

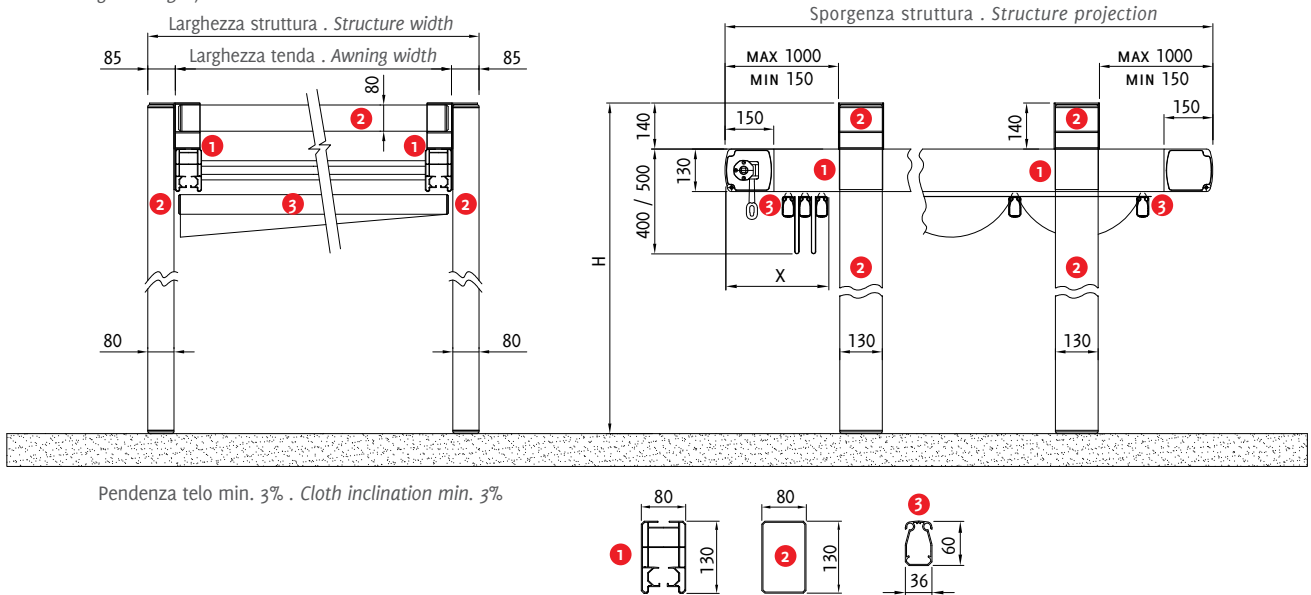

## Dati tecnici . Technical data

Quote espresse in mm - Dimensions in mm

Modulo singolo . Single form



Vista dall'alto . Top view

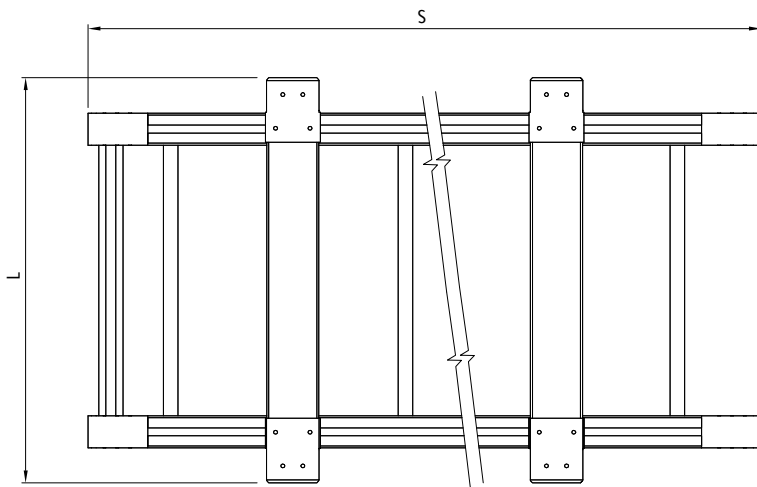

Basi in cemento . Cement base 047-953

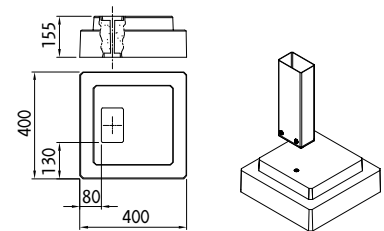

Piede a terra regolabile . Adjustable foot

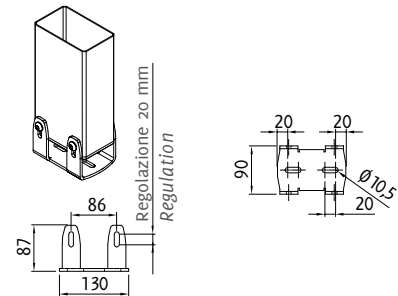

Sporgenza Projection	S cm	200	250	300	350	400	450	500	550	600
Frangitratta Flowing profiles	n °	4	5	6	7	8	9	10	11	12
Impacchettamento Packing	X cm	47	52	57	62	67	72	77	82	87

# R150 PERGOSQUARE

## Dati tecnici . Technical data

Quote espresse in mm - Dimensions in mm

Modulo doppio . Double form

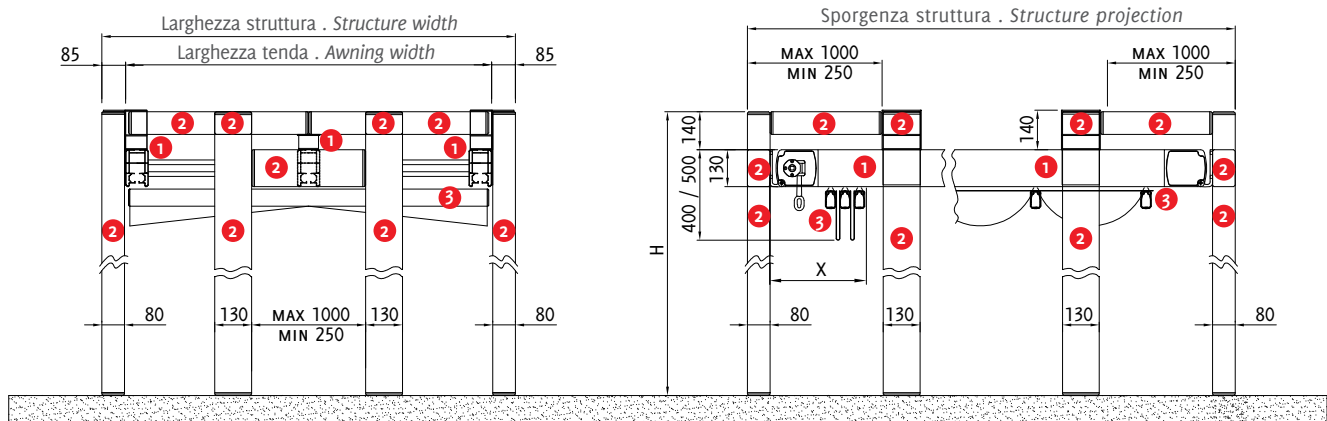

Pendenza telo min. 3% . Cloth inclination min. 3%

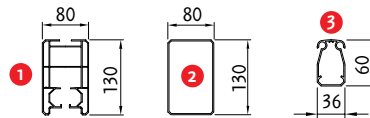

Vista dall'alto . Top view

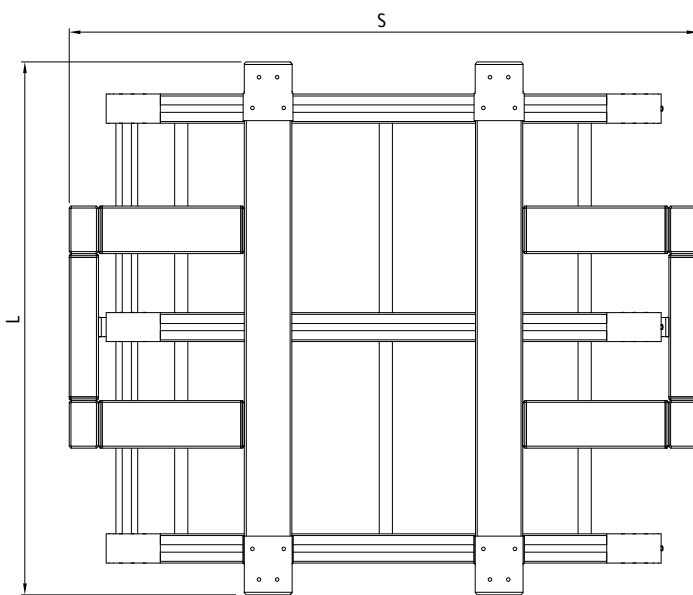

Basi in cemento . Cement base 047-953

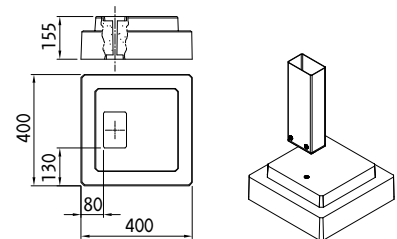

Piede a terra regolabile . Adjustable foot

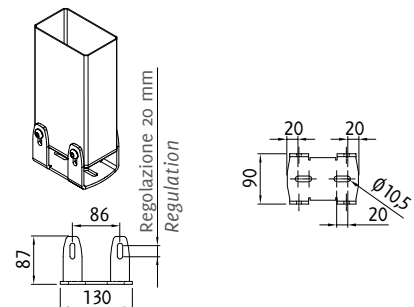

## Legenda tecnica . Technical legend

- 1 Guida . Rail
- 2 Piantana . Pole
- 3 Frangitratta . Flowing profile

- H Altezza . Height
- S Sporgenza . Projection
- L Larghezza . Width
- X Impacchettamento . Packing