

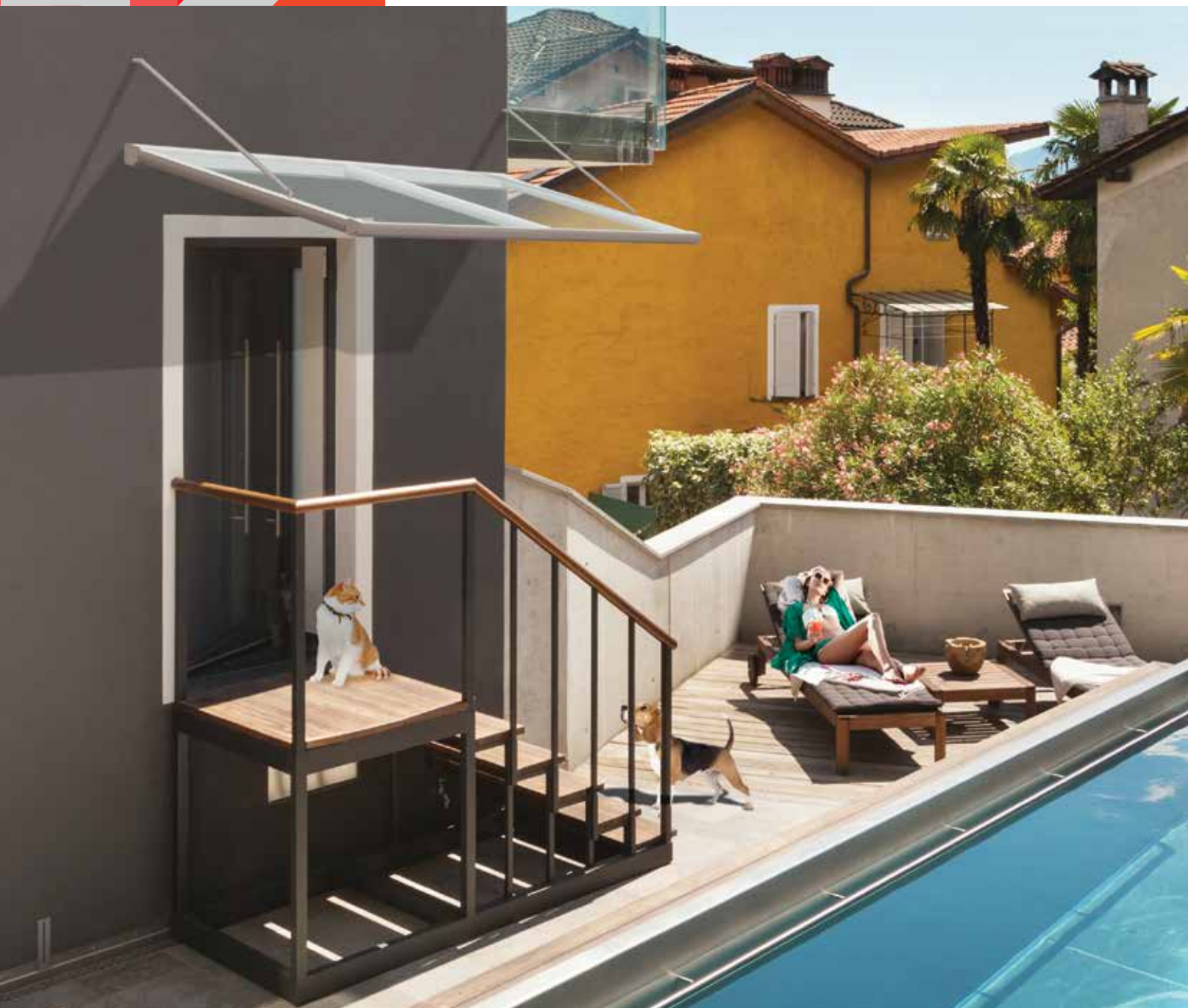

ITALIAN OUTDOOR



Pensiline e Tunnel

Vordächer und Tunnel | Marquises et Tunnel | Canopies

PENSILINE

R440/R441/R442/R443

Le nuove pensiline modulari rispecchiano il design e la qualità BT Group: sinonimo di affidabilità, sicurezza e tecnologia. Ideali per arredare con stile ingressi, vetrine, finestre e balconi.

Sistema modulare in alluminio che si contraddistingue per la semplicità di montaggio, da effettuarsi in loco, e per la qualità dei materiali.

Les nouvelles marquises modulaires reflètent le design et la qualité BT Group: synonyme de fiabilité, sûreté et technologie. Idéal pour meubler avec style entrées, vitrines, fenêtres et balcons.

Système modulaire en aluminium qui se caractérise pour la simplicité de montage, à installer sur place, et pour la qualité des matériaux.

The new modular shelters reflect BT Group quality and design: synonymous of reliability, safety and technology. Ideal to furnish with style entrances, showcases, windows and balconies.

Modular aluminum system easy to be installed and of high quality materials.

Die neuen modularen Vordäche spiegeln das Design und die Qualität BT Group wider: Synonym von Zuverlässigkeit, Sicherheit und Technologie. Ideal für Eintritte, Schaufenster, Fenster und Balkons mit Stil einzurichten.

Modulares System aus Aluminium, das sich durch seine einfache, vor Ort durchführbare Montage und die hohe Qualität seiner Materialien auszeichnet.



Protezione sole e pioggia

Sun and rain protection

Protection soleil et pluie

Sonnen-und Regenschutz



R440

PENSILINA CON SUPPORTI IN ACCIAIO / SHELTER WITH STEEL SUPPORTS
MARQUISE AVEC SUPPORTS EN ACIER / VORDACH MIT STAHLTRÄGERN

DIMENSIONI / DIMENSIONS DIMENSIONS / ABMESSUNGEN



(L)

Larghezza

Width

Largeur

Breite:

50 >>> 800 cm.

(S)

Sporgenza

Projection

Avancée

Ausladung:

85 >>> 180 cm.

CONFIGURAZIONI / CONFIGURATIONS CONFIGURATIONS / KONFIGURATIONEN

Variante "Piana"

"Piana" variant

Version "Plane"

Variante "Piana"

Variante "Raggio"

"Raggio" variant

Version "Arquée"

Variante "Raggio"

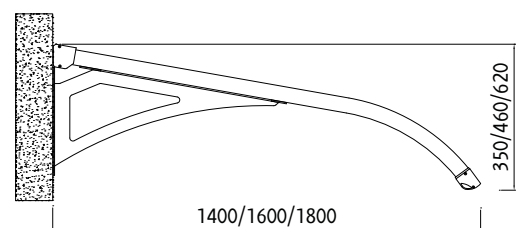
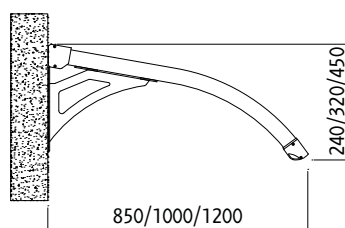
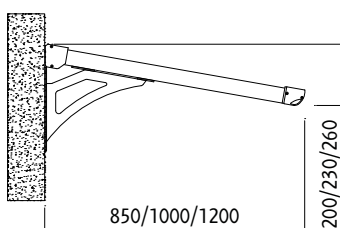

R441

PENSILINA CON BRACCETTI / SHELTER WITH ARMS
MARQUISE AVEC BRAS / VORDACH MIT ARMEN

DIMENSIONI / DIMENSIONS DIMENSIONS / ABMESSUNGEN

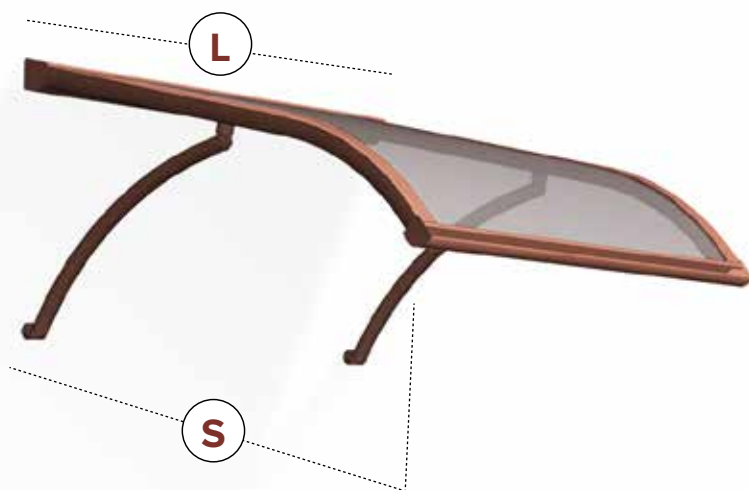

(L)

Larghezza

Width

Largeur

Breite:

50 >>> 800 cm.

(S)

Sporgenza

Projection

Avancée

Ausladung:

85 >>> 180 cm.

CONFIGURAZIONI / CONFIGURATIONS CONFIGURATIONS / KONFIGURATIONEN

Variante "Piana"

"Piana" variant
Version "Plane"
Variante "Piana"

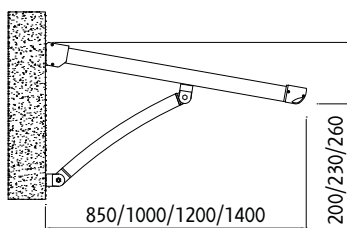

Variante "Raggio"

"Raggio" variant
Version "Arquée"
Variante "Raggio"

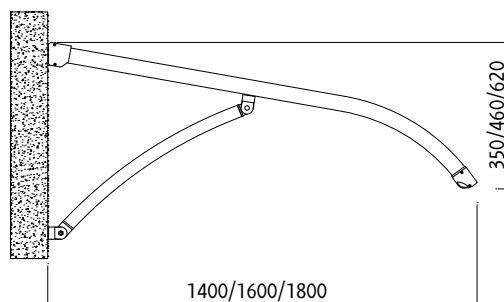
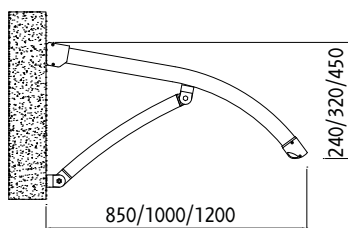





R442

PENSILINA CON TIRANTI / SHELTER WITH RODS
MARQUISE AVEC TIRANTS / VORDACH MIT ZUGSTANGEN

DIMENSIONI / DIMENSIONS DIMENSIONS / ABMESSUNGEN

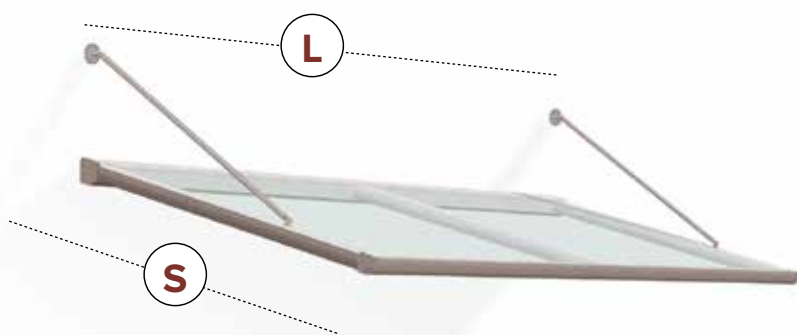

(L)

Larghezza

Width

Largeur

Breite:

50 >>> 800 cm.

(S)

Sporgenza

Projection

Avancée

Ausladung:

85 >>> 120 cm.

CONFIGURAZIONI / CONFIGURATIONS CONFIGURATIONS / KONFIGURATIONEN

Variante "Piana"

"Piana" variant

Version "Plane"

Variante "Piana"

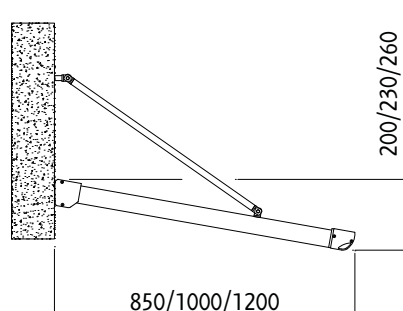



R442 PENSILINA

Pensilina con tiranti
Shelter with rods
Marquise avec tirants
Vordach mit Zugstangen



R443

PENSILINA CON SUPPORTI IN FERRO BATTUTO / SHELTER WITH WROUGHT IRON SUPPORTS
MARQUISE AVEC SUPPORTS EN FER FORGÉ / VORDACH MIT SCHMIEDEEISERNEN TRÄGERN

DIMENSIONI / DIMENSIONS DIMENSIONS / ABMESSUNGEN

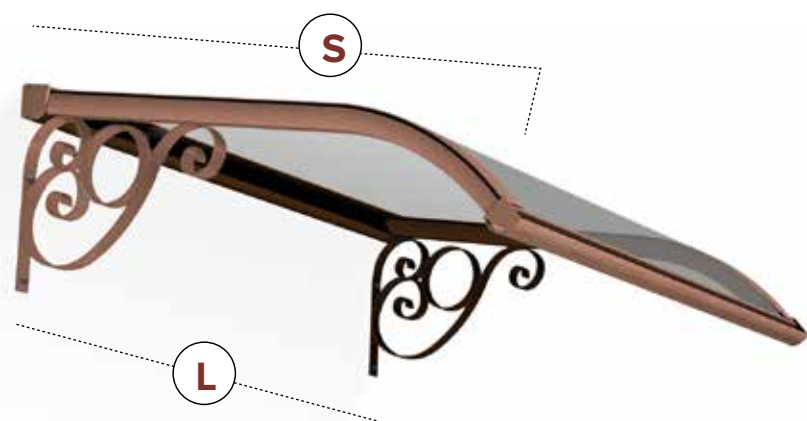

(L)

Larghezza

Width

Largeur

Breite:

50 >>> 800 cm.

(S)

Sporgenza

Projection

Avancée

Ausladung:

85 >>> 180 cm.

CONFIGURAZIONI / CONFIGURATIONS CONFIGURATIONS / KONFIGURATIONEN

Variante "Piana"

"Piana" variant
Version "Plane"
Variante "Piana"

Variante "Raggio"

"Raggio" variant
Version "Arquée"
Variante "Raggio"

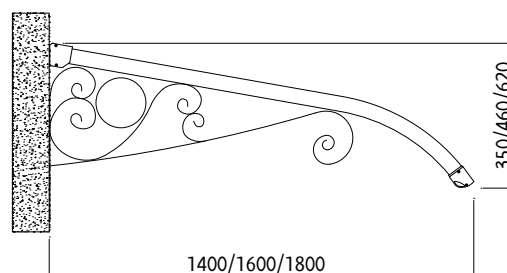
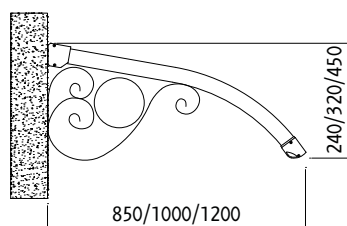
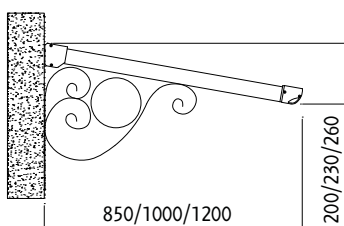



DOTAZIONI STANDARD

STANDARD EQUIPMENT / ÉQUIPEMENT STANDARD / SERIENAUSSTATTUNG



Supporto a parete.
Wall support.
Fixation murale.
Bügel für Wandbefestigung.



Gronda frontale.
Frontal water-drain.
Gouttière frontale.
Vordere Traufe.

COLORI STRUTTURA STANDARD

STRUCTURE STANDARD COLOURS

COULEURS DE STRUCTURE STANDARD

STANDARD RAHMENFARBEN



BT Group vi offre la possibilità di scegliere tra 59 colori.

BT Group offers you the possibility to choose among 59 colors.

BT Group vous offre la possibilité de choisir parmi 59 couleurs.

BT Group bietet Ihnen die Möglichkeit, aus 59 Farben auszuwählen.

POLICARBONATO

POLYCARBONATE

POLYCARBONATE

POLYCARBONAT

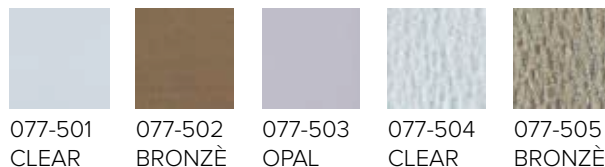

- + Autoestinguenti
- + Resistenza temperatura e rottura
- + Qualità ottiche
- + Resistenza all'abrasione e ai raggi UV
- + Isolamento termico e acustico
- + Flessibilità e termoformabilità

- + Self-extinguishing
- + Temperature and breaking strenght
- + Optical quality
- + UV and abrasion resistance
- + Thermic and sound insulation
- + Flexibility and termic formability

- + Autoextinguibles
- + Résistance température et casse
- + Qualités optiques
- + Résistance à l'abrasion et aux rayons UV
- + Isolation thermique et sonore
- + Flexibilité et thermoformage

- + Selbstlöschend
- + Temperaturbeständigkeit und Reißfestigkeit
- + Optische Qualitäten
- + Beständigkeit gegenüber Abrieb und UV-Strahlen
- + Wärme- und Schallisolierung
- + Flexibilität und thermische Verformbarkeit



Protezione sole e pioggia
Sun and rain protection
Protection soleil et pluie
Sonnen-und Regenschutz



Marchio CE
CE Mark
Marquage CE
CE-Kennzeichnung



Azienda certificata
Certification company
Entreprise certifiée
Zertifiziertes Unternehmen

TUNNEL

Struttura rigida, interamente realizzata in lega di alluminio con profili portanti con funzione di canali per la raccolta dell'acqua. La copertura può essere realizzata in policarbonato di spessore mm 4 oppure di tipo alveolare spessore mm. 6. Inoltre la copertura può essere facilmente realizzata anche in tessuto acrilico o PVC, integrabile con capottina frontale tonda o sferica. La modularità della struttura può soddisfare la maggior parte delle richieste sia di forma che di lunghezza.

Structure rigide, entièrement réalisée en alliage d'aluminium avec profils portants avec fonction de canaux pour la récolte de l'eau. La couverture peut être réalisée en polycarbonate d'une épaisseur de 4 mm ou bien de type alvéolaire d'une épaisseur de 6 mm. En outre, la couverture peut être facilement réalisée en tissu acrylique ou en PVC intégrable avec une corbeille frontale ronde ou sphérique. La modularité de la structure peut satisfaire la plupart des demandes aussi bien de forme que de longueur.

Fixed structure, entirely made of aluminium alloy with bearing profiles working as drains for water. The covering can be realized in polycarbonate 4 mm. or alveolar 6 mm. Moreover, it can be even realized of acrylic fabric or PVC, possibility of hood awnings integrated. Its modularity allows to satisfy every request of shape and length.

Starre Konstruktion, vollständig aus Aluminiumlegierung gefertigt, mit Wassersammelrinne. Die Abdeckung kann aus Polycarbonat mit einer Dicke von 4 mm oder mit Stegplatten mit einer Dicke von 6 mm realisiert werden. Außerdem kann die Abdeckung auch ganz einfach aus Acrylgewebe oder PVC gefertigt und mit einer runden oder kugelförmigen Korbmarkise an der Vorderseite ergänzt werden. Die Modularität der Struktur kann den Großteil der Anforderungen im Hinblick auf Form und Länge erfüllen.



Protezione sole e pioggia
Sun and rain protection
Protection soleil et pluie
Sonnen-und Regenschutz



Tessuti ignifughi
Fireproof fabrics
Tissus ignifuges
Feuerfeste Stoffe



TUNNEL

STRUTTURA FISSA / FIXED STRUCTURE
STRUCTURE FIXE / FESTE KONSTRUKTION

DIMENSIONI / DIMENSIONS DIMENSIONS / ABMESSUNGEN

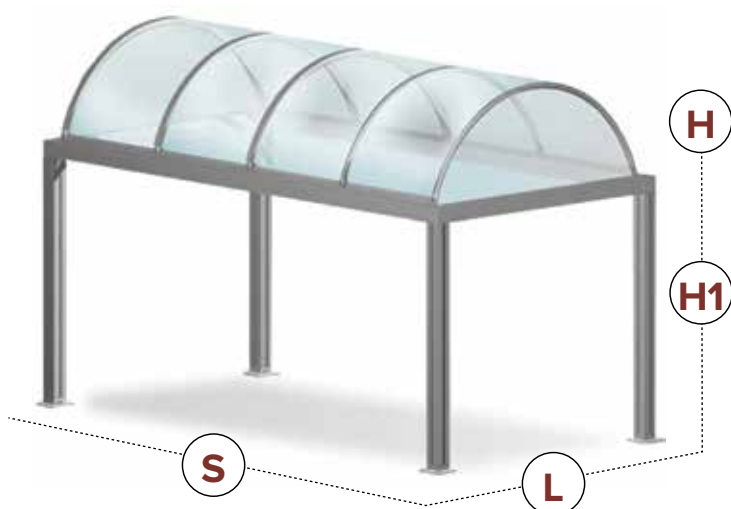

(L)

Larghezza
Width
Largeur
Breite:

200 >>> 500 cm.

(S)

Sporgenza
Projection
Avancée
Ausladung:

200 >>> 900 cm.

(H)

Altezza volta
Dome height
Hauteur Voûte
Gewölbenhöhe:

60 >>> 100 cm.

(H1)

Altezza piantana
Pole height Hauteur
Poteau
Stützen höhe:

190 >>> 250 cm.

CONFIGURAZIONI / CONFIGURATIONS CONFIGURATIONS / KONFIGURATIONEN

Addossata a parete

Wall-supporting
Structure murale
Anbau-Selbsttragende



Affiancamento laterale

Lateral Adjoining
Juxtaposition Latérale
Anordnung Voreinander



Per strutture esistenti

For existing structures
Pour structures existantes
Für bestehende Strukturen





TUNNEL



Struttura fissa
Fixed structure
Structure fixe
Feste Konstruktion



DOTAZIONI STANDARD

STANDARD EQUIPMENT / ÉQUIPEMENT STANDARD / SERIENAUSSTATTUNG



Gronda perimetrale 10x10 cm.
Perimetral gutter 10x10cm.
Gouttière périmétrique 10x10 cm.
Außen Wasserrinne 10x10 cm.



Piede a terra.
Foot.
Pied au sol.
Bodenelement.

COLORI STRUTTURA STANDARD

STRUCTURE STANDARD COLOURS

COULEURS DE STRUCTURE STANDARD

STANDARD RAHMENFARBEN

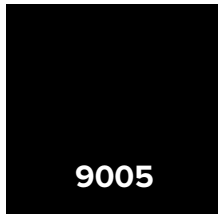

BT Group vi offre la possibilità di scegliere tra 59 colori.

BT Group offers you the possibility to choose among 59 colors.

BT Group vous offre la possibilité de choisir parmi 59 couleurs.

BT Group bietet Ihnen die Möglichkeit, aus 59 Farben auszuwählen.

ALVEOLARE / ALVEOLAR

ALVEOLAIRE / ALVEOLÄR



077-511
CLEAR

077-512
BRONZÈ

077-513
OPAL

TESSUTI

FABRICS

TISSUS

GEWEBE



TEMPOTEST / STARLIGHT



PVC 302 / PVC 502 SATIN



LIBERTY / RESINATI

WATERPROOF
IMPERMEABLES
WASSERDICHT



REVERSE



SOLTIS

POLICARBONATO / POLYCARBONATE

POLYCARBONATE / POLYCARBONAT



077-501
CLEAR

077-502
BRONZÈ

077-503
OPAL

077-504
CLEAR

077-505
BRONZÈ



Protezione sole e pioggia
Sun and rain protection
Protection soleil et pluie
Sonnen- und Regenschutz



Tessuti ignifughi
Fireproof fabrics
Tissus ignifuges
Feuerfeste Stoffe



Marchio CE
CE Mark
Marquage CE
CE-Kennzeichnung



Azienda certificata
Certification company
Entreprise certifiée
Zertifiziertes Unternehmen



ITALIAN OUTDOOR

BT Group si riserva il diritto di modificare in qualsiasi momento e senza preavviso i dati del presente stampato. Le foto sono puramente indicative e non costituiscono nessun vincolo contrattuale. Ogni riproduzione, anche se parziale, è vietata.

BT Group reserves the right to change these printed datas at any time with any warning. Pictures are purely indicative and don't constitute any contractual obligastion. Any part, even if partial, can't be reproduced.

BT Group se réserve le droit de modifier à tout moment et sans préavis les données de cette brochure. Les photos sont à titre purement indicatif et ne constituent aucune obligation contractuell. Toute reproduction, même partielle, est interdite.

BT Group behält sich das Recht vor, zu jedem beliebigen Zeitpunkt und ohne vorherige Ankündigung Änderungen an den Daten der vorliegenden Veröffentlichung vorzunehmen. Die abgebildeten Fotografien dienen lediglich der Veranschaulichung und stellen keinerlei vertragliche Verpflichtungen dar.

