

Dati tecnici . Technical data

Quote espresse in mm - Dimensions in mm

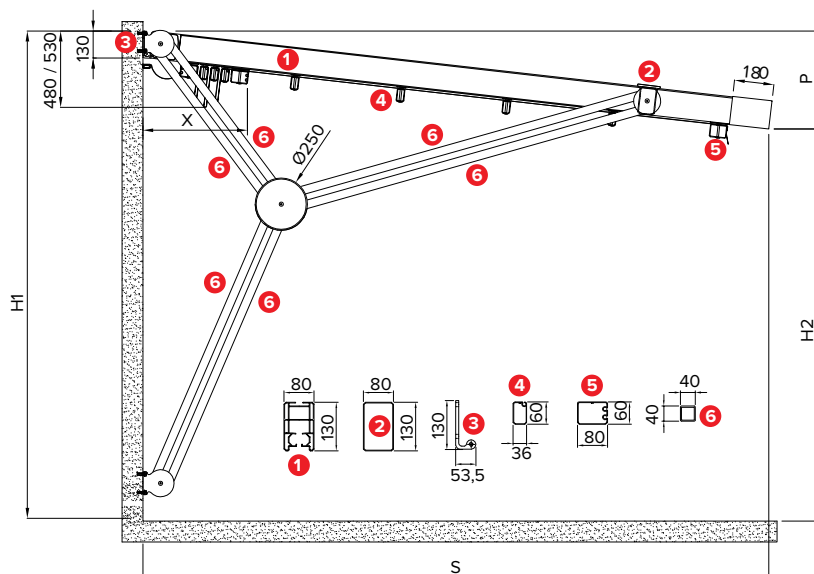

Vista frontale . Frontal view

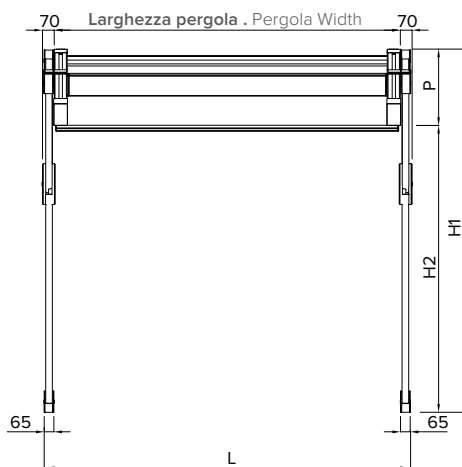

Sporgenza Projection	S cm	200	250	300	350	400	450	500
Pendenza minima Least inclination	P cm	Vedi pag. 14 . See page 14						
Frangitratta intermedi indicativi Indicative middle flowing profiles	n°	2	3	4	5	6	7	8
Impacchettamento Packing	X cm	47	52	57	62	67	72	77

Se la struttura non ha le caratteristiche indicate, BT Group non si assume la responsabilità per eventuali sacche d'acqua e problematiche inerenti al deflusso dell'acqua piovana. Il numero dei frangitratta è indicativo, le pendenze sono le minime garantite per un corretto deflusso dell'acqua piovana. Per pendenze inferiori alle misure minime, indicate in tabella, è possibile aggiungere uno o più montanti intermedi, salvo approvazione dell'ufficio tecnico.

If this structure doesn't have these indicated features, BT Group will not be responsible for possible knapsacks of water or similar problems concerning the outflow of rainwater. Indicative flowing profiles number, inclinations are the least guaranteed for a correct outflow of rainwater. For inclinations lower than the minimum required measures, it is possible to add one or more middle flowing profiles, except for technical office approval.

R240 GALAXY

Dettagli tecnici . Technical details

Quote espresse in mm - Dimensions in mm

Piastra attacco a parete . Wall connection

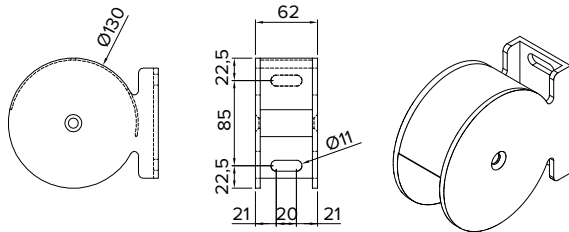

Tettuccio giunzione pergole . Connection roof
033 - 950

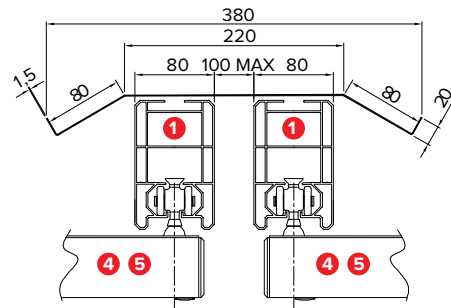

Profilo antivento . Antiwind profile
047 - 959

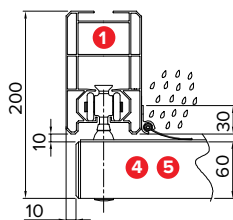

Dettaglio tettuccio . Roof detail

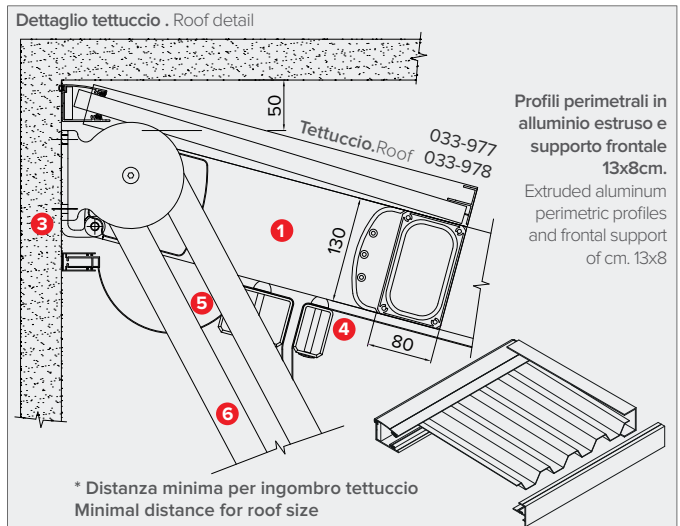

Staffa attacco parete
Wall application bracket

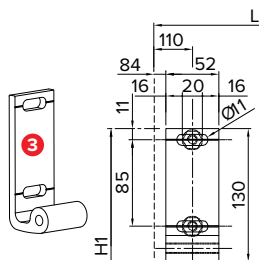

Legenda tecnica . Technical legend

- 1 Guida . Rail
- 2 Traverso frontale . Frontal crossbeam
- 3 Staffa attacco parete . Wall application bracket
- 4 Frangitratta intermedio . Middle flowing profile
- 5 Frangitratta terminale . Last flowing profile
- 6 Profilo di sostegno . Support profile

- H1 Altezza posteriore . Back height
- H2 Altezza frontale . Frontal height
- S Sporgenza . Projection
- P Pendenza . Inclination
- L Larghezza . Width
- X Impacchettamento . Packing